



**CANOPIA**<sup>®</sup>  
by PALRAM

# HOW TO ASSEMBLE

## BASE KIT<sup>™</sup>

Compatible with Palram Canopia's:

Eco Grow<sup>®</sup> 6x6 / 2x2 | 6x8 / 2x2.6 | 6x10 / 2x3.3 |  
6x12 / 2x4 | 6x14 / 2x4.5

Hobby Gardener<sup>®</sup> | Grand Gardener<sup>®</sup> | Prestige<sup>™</sup>  
8x8 / 2.7x2.7 | 8x12 / 2.7x4 | 8x16 / 2.7x5 |  
8x20 / 2.7x6.4

### IMPORTANT!

Please read these instructions carefully before starting assembly.  
Keep these instructions in a safe place for future reference.

[www.canopia.com](http://www.canopia.com)



A member of  
Palram Industries Ltd.

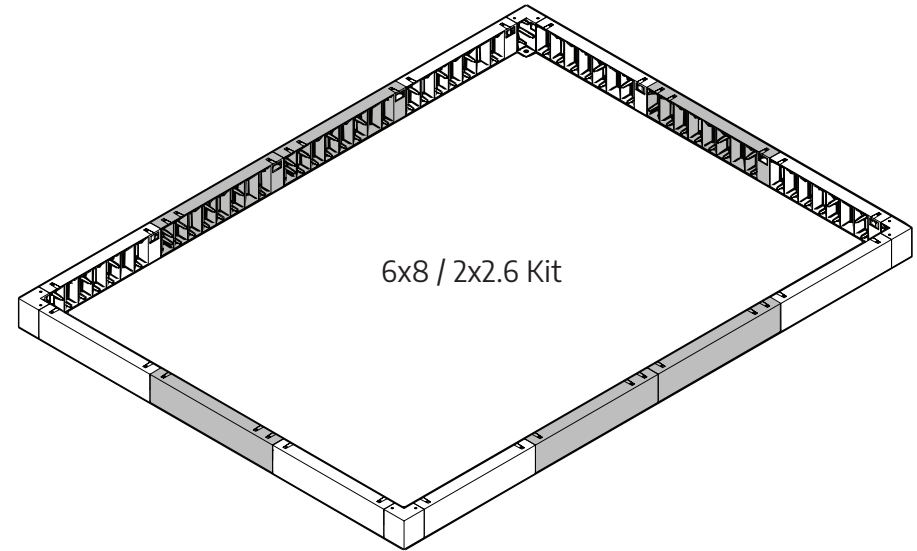

6x8 / 2x2.6 Kit

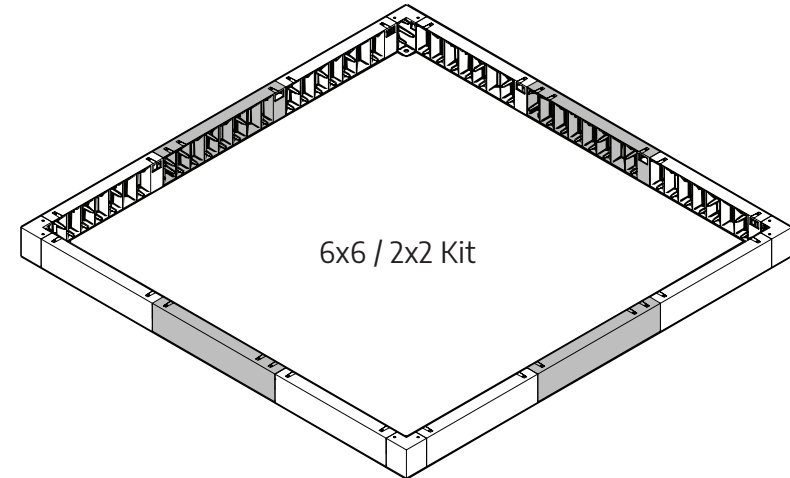

6x6 / 2x2 Kit

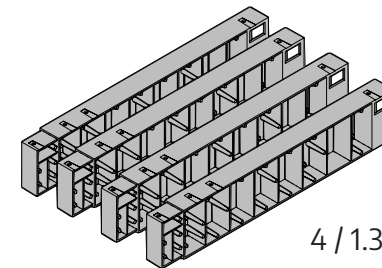

4 / 1.3 Extension Kit



# AVAILABLE SIZES

6x6 / 2x2

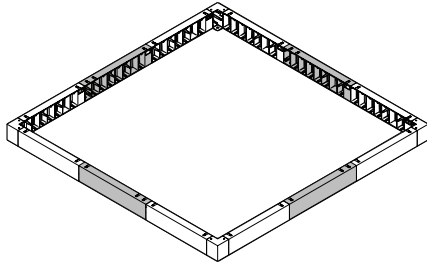

6x6 / 2x2 Kit

**1 BOX**

6x8 / 2x2.4

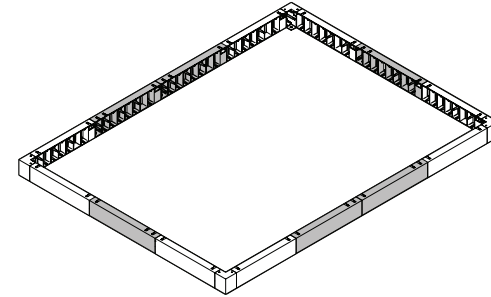

6x8 / 2x2.4 Kit

**1 BOX**

6x10 / 2x3.3

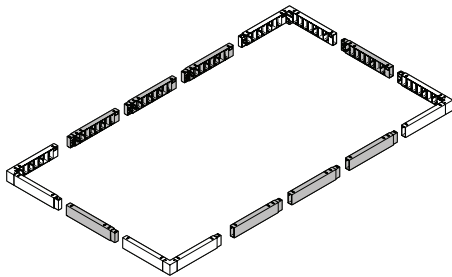

6x6 / 2x2 Kit

**1 BOX**

4 / 1.3 Extension Kit

**1 BOX**

6x12 / 2x4

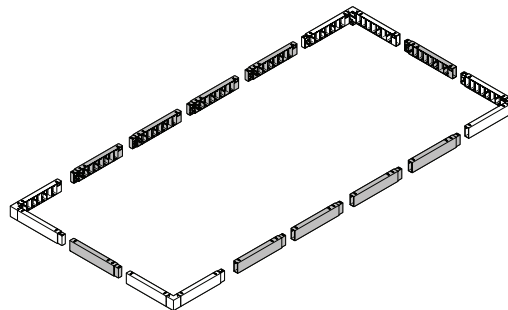

6x8 / 2x2.4 Kit

**1 BOX**

4 / 1.3 Extension Kit

**1 BOX**

6x14 / 2x4.5

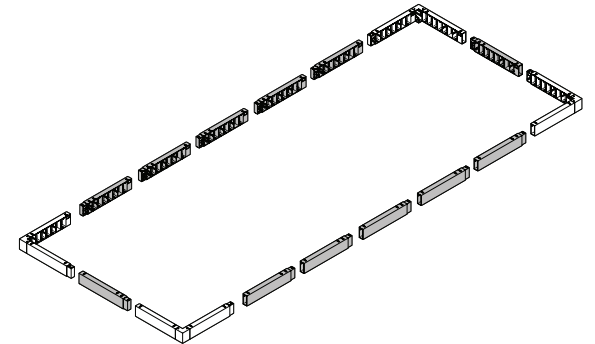

6x6 / 2x2 Kit

**1 BOX**

4 / 1.3 Extension Kit

**2 BOXES**



# AVAILABLE SIZES

8x8 / 2.7x2.7

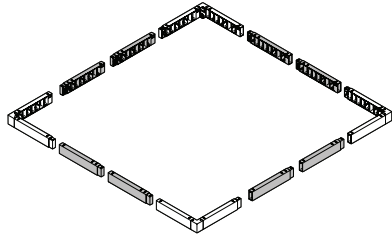

6x6 / 2x2 Kit

**1 BOX**

4 / 1.3 Extension Kit

**1 BOX**

8x12 / 2.7x4

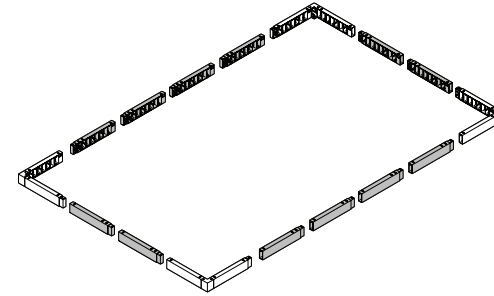

6x6 / 2x2 Kit

**1 BOX**

4 / 1.3 Extension Kit

**2 BOXES**

8x16 / 2.7x5

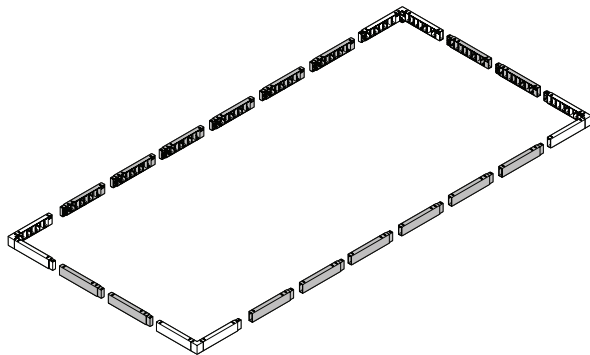

6x6 / 2x2 Kit

**1 BOX**

4 / 1.3 Extension Kit

**3 BOXES**

8x20 / 2.7x6.4

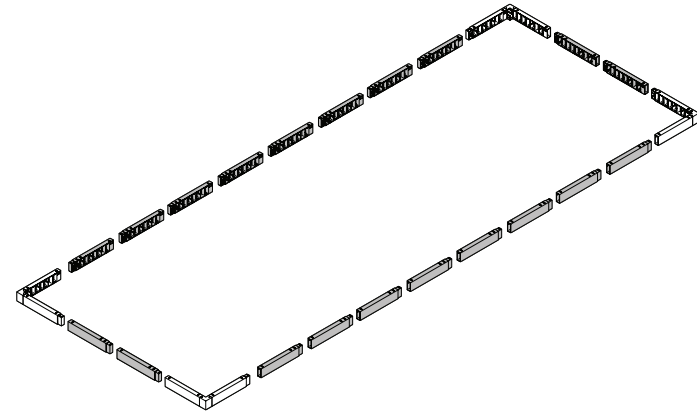

6x6 / 2x2 Kit

**1 BOX**

4 / 1.3 Extension Kit

**4 BOXES**



# 1

## PARTS REQUEST

**In the case of missing or damaged parts, do not return product to store.**

Go to the link below or scan the QR code for help, it will direct you to a form that will help us assist you as soon as possible.



SCAN ME

Contact us on our website:  
[bit.ly/3js7yZi](https://bit.ly/3js7yZi)

# 2

## ASSEMBLY ASSISTANCE

If you need any technical assistance in assembling your product, go to the link below or scan the QR code for help. It will direct you to a form that will help us assist you as soon as possible.



SCAN ME

Contact us on our website:  
[bit.ly/3kqqFEc](https://bit.ly/3kqqFEc)



## CUSTOMER SUPPORT



SCAN ME

# WE ARE HERE TO HELP

For general questions: [bit.ly/3kY07dP](https://bit.ly/3kY07dP)

### USA

 877-627-8476

 [hobbyservice@poly-tex.com](mailto:hobbyservice@poly-tex.com)

### CANADA

 905-5646007

 [sales@footprintproducts.com](mailto:sales@footprintproducts.com)

### UNITED KINGDOM · IRELAND

 01302-380775

 [customer.serviceUK@palram.com](mailto:customer.serviceUK@palram.com)

### GERMANY

 0180-522-8778

 [customer.serviceDE@palram.com](mailto:customer.serviceDE@palram.com)

### FRANCE · BELGIUM

 +33-169-791-094

 [customer.serviceFR@palram.com](mailto:customer.serviceFR@palram.com)

### ISRAEL

 04-848-6816

 [info.il@palram.co.il](mailto:info.il@palram.co.il)

### ITALY · NETHERLANDS · PORTUGAL · SPAIN

 +33-169-791-094

 [customer.serviceFR@palram.com](mailto:customer.serviceFR@palram.com)

### AUSTRIA · LUXEMBURG · LIECHTENSTEIN

 +49-180-522-8778

 [customer.serviceDE@palram.com](mailto:customer.serviceDE@palram.com)

### AUSTRALIA

 03-9219-4444

 [salesvic@palram.com](mailto:salesvic@palram.com)

NORWAY · SWEDEN · ARGENTINA · GREECE · GREENLAND · ICELAND · ESTONIA · JAPAN · LATVIA · LITHUANIA  
MAURITIUS · MEXICO · ROMANIA · RUSSIA · TURKEY · UZBEKISTAN · UKRAINE · SWAZILAND · KOREA

 +972-4-848-6816

 [customer.service@palram.com](mailto:customer.service@palram.com)



## CUSTOMER SUPPORT



SCAN ME

# WE ARE HERE TO HELP

For general questions: [bit.ly/3kY07dP](https://bit.ly/3kY07dP)

### AUSTRALIA - GREENHOUSES

 03-9544-6-999

 [info@mazedistribution.com.au](mailto:info@mazedistribution.com.au)

### HUNGARY · SLOVAKIA

 +420-493-523-523

 [servis@garland.cz](mailto:servis@garland.cz)

### NEW ZEALAND

 0800 800 880

 [customer.service@palram.com](mailto:customer.service@palram.com)

### DENMARK

 07-575 42 70

 [post@nshnordic.com](mailto:post@nshnordic.com)

### SOUTH AFRICA

 011-397-7771

 [receptionza@palram.com](mailto:receptionza@palram.com)

### CROATIA · SLOVENIA

 0599-37-057

 [info@ms-viscom.com](mailto:info@ms-viscom.com)

### CZECH REPUBLIC

 0493-523-523

 [servis@garland.cz](mailto:servis@garland.cz)

### FINLAND

 Neuvonta: 09-6866720  
Tuki / Varaosat: 050-3715350

 [www.horisontenterprises.fi](http://www.horisontenterprises.fi)  
[tuki@horisontenterprises.fi](mailto:tuki@horisontenterprises.fi)

### POLAND

 Infolinia: 801-011-929  
22-349-93-36

 [kontakt@ogrodosfera.pl](mailto:kontakt@ogrodosfera.pl)

### CYPRUS

 0224-971-13

 [alpaco@alpacodomica.com](mailto:alpaco@alpacodomica.com)  
[www.alpacodomica.com](http://www.alpacodomica.com)

### SWITZERLAND

 062-287-33-77

 [info@ritter.ch](mailto:info@ritter.ch)

## SAFETY ADVICE

- Dispose of all plastic bags safely – keep them away from children’s reach.
- Keep children away from the assembly area.
- When using a stepladder or power tools, make sure that you are following the manufacturer’s safety advice.

## IMPORTANT RECOMMENDATIONS

- These instructions are compatible with Palram Canopia’s:  
Eco Grow® 6x6 / 2x2 | 6x8 / 2x2.6 | 6x10 / 2x3.3 | 6x12 / 2x4 | 6x14 / 2x4.5  
Hobby Gardener® | Grand Gardener® | Prestige™  
8x8 / 2.7x2.7 | 8x12 / 2.7x4 | 8x16 / 2.7x5 | 8x20 / 2.7x6.4
- Please carry out the steps in the order set out in these instructions.
- Keep these instructions in a safe place for future reference.
- We recommend checking for restrictions or covenants for building this product in your area. In addition we advise to check if you need to submit any forms or if any permit is required prior to building the product.

## BEFORE ASSEMBLY

1. Please read these instructions carefully before you start to assemble this product.
2. Some of the steps may require the assistance of a second person.
3. The Base kit must be assembled before assembling the greenhouse.
4. If greenhouse is already assembled, it must be disassembled in order to add the Base Kit.
5. Assemble the base parts of the greenhouse to the Base Kit before continuing to assemble the greenhouse as shown in **Step 4**.

## TOOLS & EQUIPMENT

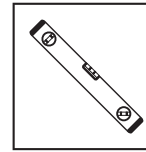

□ Spirit Level

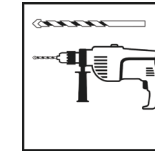

□ Electric Drill  
With Drill Bit

## PREPARE THE SITE

The product must be built on a **solid and leveled** surface in order to perform properly.

### 1 - Clear the site



### 2 - Level the ground

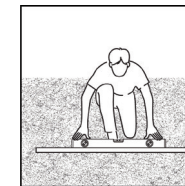
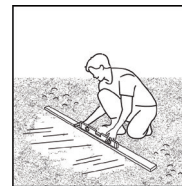



## IMPORTANT ASSEMBLY STEPS

**When encountering this information icon during assembly, please refer to the relevant assembly step for important additional comments.**

**Step 2:** After assembling the corners, layout all connecting parts based on the greenhouse size.

**Step 4:** Assemble the base parts of the greenhouse to the Base Kit before continuing to assemble the greenhouse.

**Step 5:** **OPTION 1**

**When mounting above ground.**

1. Attach the corners to the ground.
2. Secure the product to the foundation of your choice, using suitable screws & plugs or masonry anchors (not supplied). After securing the base kit, fill it with soil or concrete to the height of the kit.

**OPTION 2**

**When mounting on firm ground, grass, soil, or gravel.**

1. Dig into the ground at the height of the kit, place the base kit inside and level it.
2. After securing the base kit, fill it with soil or concrete to the height of the kit.



## CONSEILS DE SECURITE

- Jetez précautionneusement tous les sacs plastiques – tenez-les hors de portée des enfants.
- Tenez les enfants à distance de la zone de montage.
- Si vous utilisez un escabeau ou des outils électriques, assurez-vous de respecter les consignes de sécurité du fabricant.

## RECOMMANDATIONS IMPORTANTES

- Ces instructions ne sont compatibles qu'avec le Gazebo du jardin Palram Canopia's Eco Grow® 6x6 / 2x2 | 6x8 / 2x2.6 | 6x10 / 2x3.3 | 6x12 / 2x4 | 6x14 / 2x4.5 Hobby Gardener® | Grand Gardener® | Prestige™ 8x8 / 2.7x2.7 | 8x12 / 2.7x4 | 8x16 / 2.7x5 | 8x20 / 2.7x6.4
- Veuillez suivre les étapes dans l'ordre indiqué dans ces instructions.
- Conservez ces instructions en lieu sûr pour référence ultérieure.
- Avant d'assembler ce produit dans votre région, nous vous recommandons de vous renseigner sur les restrictions ou réglementations locales. Nous vous conseillons en outre de vérifier si vous devez soumettre des formulaires ou si un permis est requis avant de monter le produit.

## AVANT LE MONTAGE

1. Veuillez lire attentivement ces instructions avant de commencer l'assemblage de ce produit.
2. Certaines étapes nécessitent l'aide d'une deuxième personne.
3. Le kit de base doit être assemblé avant de monter la serre.
4. Si la serre est déjà assemblée, elle doit être démontée avant que le kit de base puisse être ajouté.
5. Assemblez les pièces de la base de la serre dans le kit de base avant de procéder à l'assemblage de la serre, comme indiqué à l'étape 4.

## OUTILS ET ÉQUIPEMENT

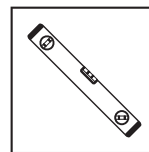

□ Niveau

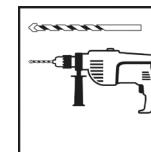

□ Perceuse filaire avec foret

## PRÉPARER LE TERRAIN

Le produit doit être monté sur une **surface solide et nivelée** afin d'en assurer la bonne stabilité.

### 1 - Déblayer le terrain

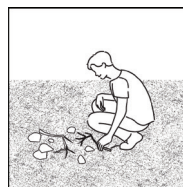

### 2 - Nivelier le sol

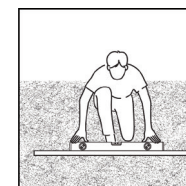



## PRINCIPALES ÉTAPES D'ASSEMBLAGE

**Lorsque vous rencontrez cette icône d'information pendant l'assemblage, veuillez vous référer à l'étape d'assemblage correspondante pour d'autres commentaires importants.**

### Étape 2:

Après avoir assemblé les coins, ajustez toutes les pièces de raccordement en fonction de la taille de la serre.

### Étape 4:

Assemblez les pièces de la base de la serre dans le kit de base avant de poursuivre l'assemblage de la serre.

### Étape 5:

#### OPTION 1

**Lors d'une installation hors sol.**

1. Fixez les coins au sol.
2. Fixez le produit à la base choisie, en utilisant des vis et des chevilles appropriées ou des ancrages de maçonnerie (non fournis). Après avoir fixé le kit de base, remblayez avec de la terre ou du béton pour compléter le niveau de hauteur du kit.

#### OPTION 2

**Lors de l'installation sur un sol ferme, de l'herbe, de la terre ou du gravier.**

1. Creusez le sol à une profondeur équivalente à la hauteur du kit, placez le kit de base à l'intérieur et mettez-le à niveau.
2. Après avoir fixé le kit de base, remplissez-le de terre ou de béton jusqu'à ce que la hauteur du kit soit complète.

## SICHERHEITSHINWEISE

- Entsorgen Sie die Plastikbeutel vorschriftsgemäss – und achten Sie darauf, dass sie nicht in Reichweite von Kindern kommen.
- Halten Sie Kinder während des Aufbaus vom Carport fern.
- Wenn Sie eine Stufenleiter oder Elektrowerkzeuge benutzen, achten Sie darauf, die Sicherheitshinweise des Herstellers zu befolgen.

## WICHTIGE HINWEISE

- Diese Anweisungen sind nur gültig für Palram Canopia's Eco Grow® 6x6 / 2x2 | 6x8 / 2x2.6 | 6x10 / 2x3.3 | 6x12 / 2x4 | 6x14 / 2x4.5 Hobby Gardener® | Grand Gardener® | Prestige™ 8x8 / 2.7x2.7 | 8x12 / 2.7x4 | 8x16 / 2.7x5 | 8x20 / 2.7x6.4
- Bitte führen Sie die einzelnen Schritte in der in dieser Anleitung angegebenen Reihenfolge durch.
- Bewahren Sie diese Anleitung für späteren Gebrauch sicher auf.
- Bevor Sie mit der Montage beginnen, vergewissern Sie sich bitte beim zuständigen Bauamt, ob es in Ihrer Region Einschränkungen oder Auflagen für den Bau des gewählten Produktes gibt. Wir bitten Sie außerdem zu prüfen, ob eine Genehmigung für den Bau erforderlich ist.

## VOR DEM ZUSAMMENBAU

1. Um den Pavillon vollständig zu bedecken, müssen Sie eine weitere Garnitur kaufen.
2. Einige der Arbeitsgänge machen es notwendig, dass eine zweite Person zur Hand geht
3. Der Grundbausatz (Base Kit) ist vor dem Zusammenbau des Gewächshauses zu montieren.
4. Wenn das Gewächshaus bereits zusammengebaut wurde, muss es demontiert werden, um das Basis-Kit hinzuzufügen.
5. Montieren Sie die Bodenteile des Gewächshauses an den Grundbausatz (Base Kit), bevor Sie mit dem Zusammenbaudes Gewächshauses wie in Schritt 4 beschrieben fortfahren.

## WERKZEUGE & AUSRÜSTUNG

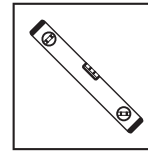

□ Wasserwaage

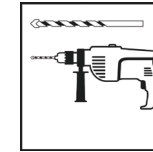

□ Bohrmaschine mit Bohrer

## VORBEREITUNG DES UNTERGRUNDES

Das Produkt muss auf einem **festen und absolut ebenmäßigen** Untergrund aufgebaut werden, um eine einwandfreie Funktion zu gewährleisten.

### 1 - Standort säubern

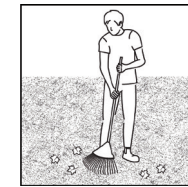

### 2 - Untergrund ausgleichen und nivellieren

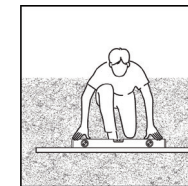
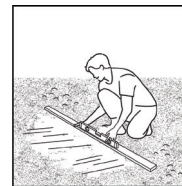



## WICHTIGE MONTAGESCHRITTE

**Wenn Sie bei der Montage auf dieses Informationssymbol stoßen, finden Sie im jeweiligen Montageschritt wichtige Zusatzhinweise.**

**Schritt 2:** Nach dem Zusammenbau der Ecken legen Sie alle Verbindungsteile entsprechend der Gewächshausgröße aus.

**Schritt 4:** Montieren Sie die Bodenteile des Gewächshauses an den Grundbausatz (Base Kit), bevor Sie mit dem Zusammenbau des Gewächshauses fortfahren.

### **Schritt 5:** **OPTION 1**

**Bei die Aufstellung über der Bodenhöhe.**

1. Befestigen Sie die Ecken auf dem Boden.
2. Befestigen Sie das Produkt mit geeigneten Schrauben und Dübeln oder Mauerankern (nicht im Lieferumfang enthalten) an einem Fundament Ihrer Wahl. Füllen Sie das Fundament nach der Befestigung des Grundbausatzes (Base Kit) bis zur Höhe des Kits mit Erde oder Beton auf.

### **OPTION 2**

**Bei Montage auf festem Untergrund, Gras, Erde oder Kiesel.**

1. Graben Sie den Boden bis zur Höhe des Bausatzes ein, setzen Sie den Grundbausatz (Base Kit) hinein und nivellieren Sie ihn.
2. Füllen Sie das Fundament nach der Befestigung des Basisbausatzes (Base Kit) bis zur Höhe des Kits mit Erde oder Beton auf.

## CONSEJOS DE SEGURIDAD

- Tire todas las bolsas de plástico con seguridad; manténgalas fuera del alcance de los niños pequeños.
- Mantenga a los niños lejos del área de montaje.
- Cuando utilice una escalera de mano o herramientas eléctricas, asegúrese de seguir los consejos de seguridad del fabricante.

## RECOMENDACIONES IMPORTANTES

- These instructions are compatible with Palram Canopia's:  
Eco Grow® 6x6 / 2x2 | 6x8 / 2x2.6 | 6x10 / 2x3.3 | 6x12 / 2x4 | 6x14 / 2x4.5  
Hobby Gardener® | Grand Gardener® | Prestige™  
8x8 / 2.7x2.7 | 8x12 / 2.7x4 | 8x16 / 2.7x5 | 8x20 / 2.7x6.4
- Siga los distintos pasos en el mismo orden de las instrucciones.
- Guarde las instrucciones en un lugar seguro para poder consultarlas en el futuro.
- Recomendamos comprobar las restricciones o convenios para la construcción de este producto en su área. Además, aconsejamos comprobar si necesita presentar algún formulario o si se requiere algún permiso antes de construir el producto.

## ANTES DEL ENSAMBLAJE

1. Por favor, lea estas instrucciones cuidadosamente antes de comenzar a montar este producto.
2. Algunos de los pasos pueden requerir ayuda de una segunda persona.
3. El Kit de base debe estar ensamblado antes de armar el invernadero.
4. Si el invernadero ya está armado, debe desarmarse para poder añadir el Kit de base.
5. Ensamble las partes de la base del invernadero en el Kit de base antes de continuar con el armado del invernadero, como se muestra en el **Paso 4**.

## HERRAMIENTAS Y EQUIPOS

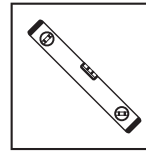

□ Regla de nivel

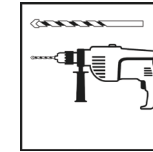

□ Taladro eléctrico con broca o mecha

## PREPARE THE SITE

Este producto debe construirse sobre una **base sólida y una superficie nivelada** para que funcione correctamente.

### 1 - Limpie el sitio

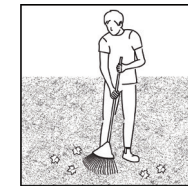

### 2 - Nivele el terreno

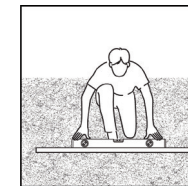



## PASOS DE MONTAJE IMPORTANTES

**Al encontrar este icono de información durante el montaje, consulte el paso de montaje correspondiente para obtener importantes comentarios adicionales.**

**Paso 2:** Después de ensamblar las esquinas, coloque todas las piezas de conexión en función del tamaño del invernadero

**Paso 4:** Ensamble las piezas de la base del invernadero en el Kit de base antes de continuar con el armado del invernadero.

## **Paso 5:** OPCIÓN 1

**Cuando realice la instalación sobre el suelo.**

1. Fije las esquinas al suelo.
2. Asegure el producto a la base elegida, utilizando tornillos y tacos adecuados o anclajes de mampostería (no suministrados). Después de fijar el Kit de base, rellénelo con tierra u hormigón hasta completar el nivel de altura del kit.

## **OPCIÓN 2**

**Cuando la instalación se realiza sobre un terreno firme, césped, tierra o grava.**

1. Excave en el suelo a una profundidad equivalente a la altura del kit, coloque el Kit de base en su interior y nivélelo.
2. Después de fijar el Kit de base, rellénelo con tierra u hormigón hasta completar el nivel de altura del kit.

**Contents**

<b>6'x6' kit</b>		<b>6'x8' kit</b>		<b>Ext. kit</b>	
Item	Qty.	Item	Qty.	Item	Qty.
7320	4	7320	6	7320	4
7321	4	7321	4		
7322	8	7322	8		
429	4	429	4		
7225	24	7225	28	7225	8
466	24	466	28	466	8

1

a

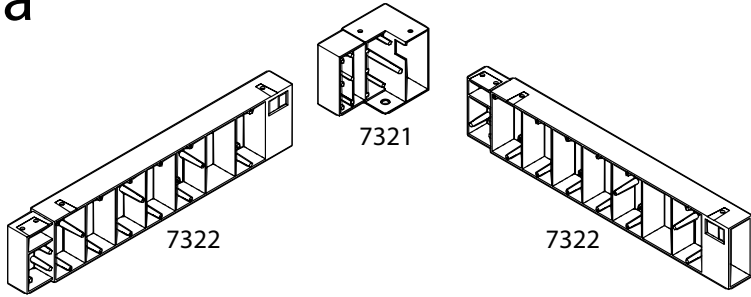

b

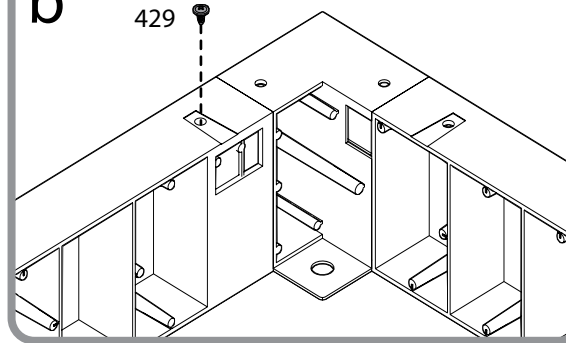

2



After assembling the corners, layout all connecting parts based on the greenhouse size.

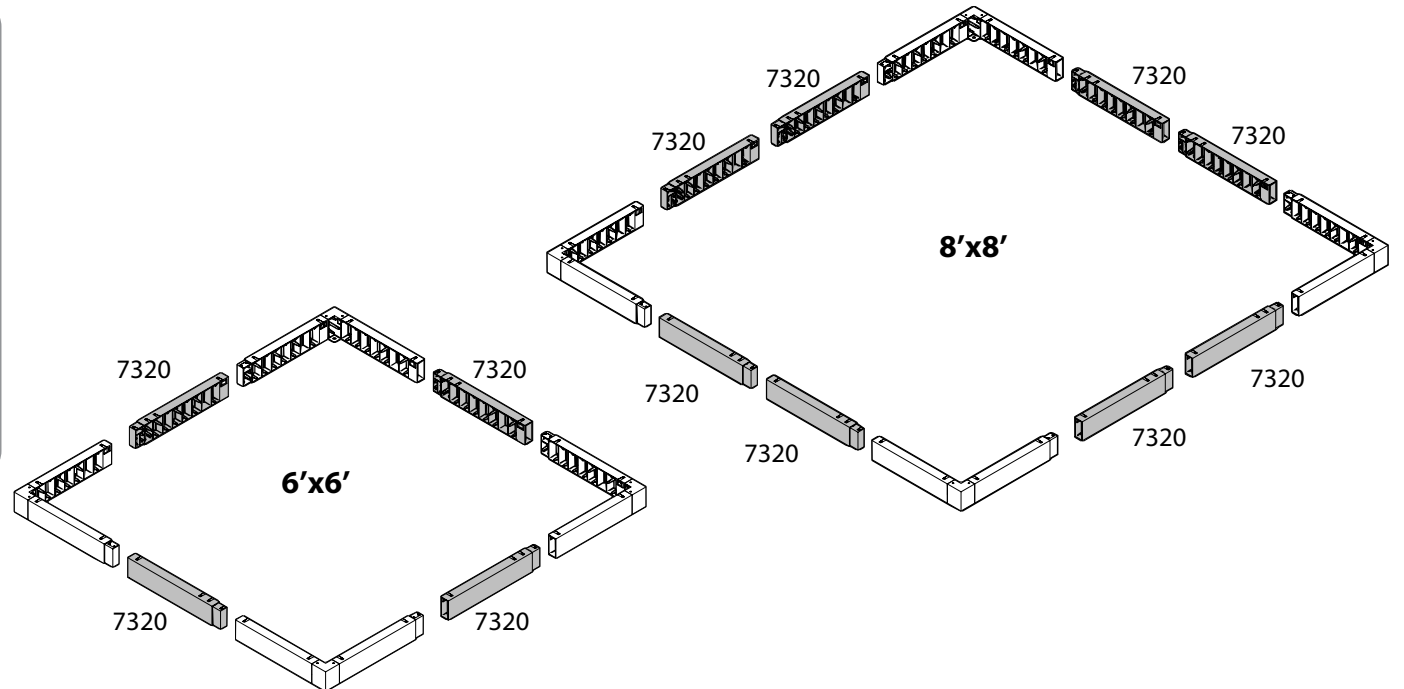
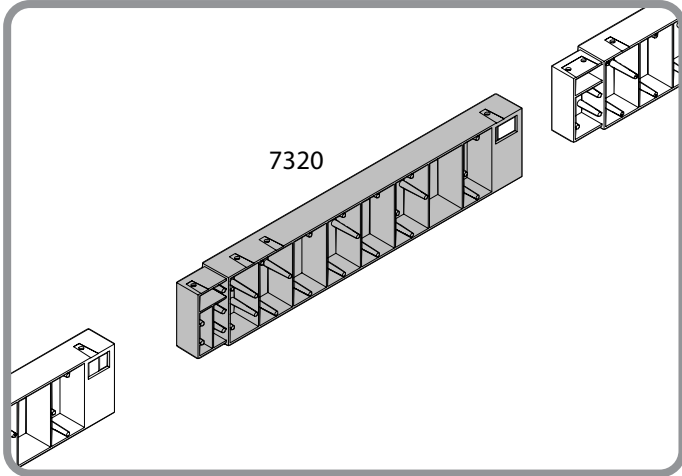



3

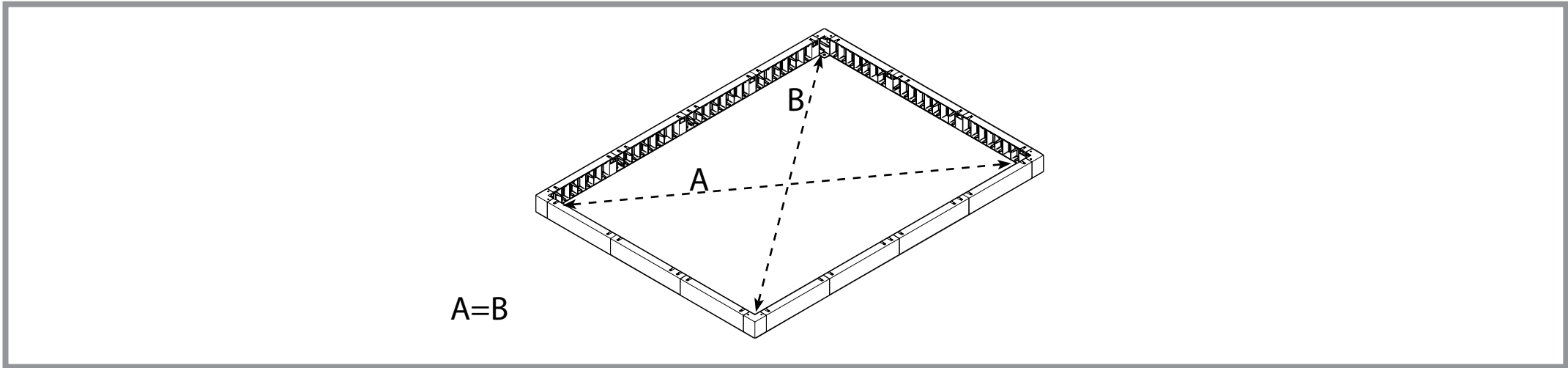

4



Assemble the base parts of the greenhouse to the Base Kit before continuing to assemble the greenhouse.

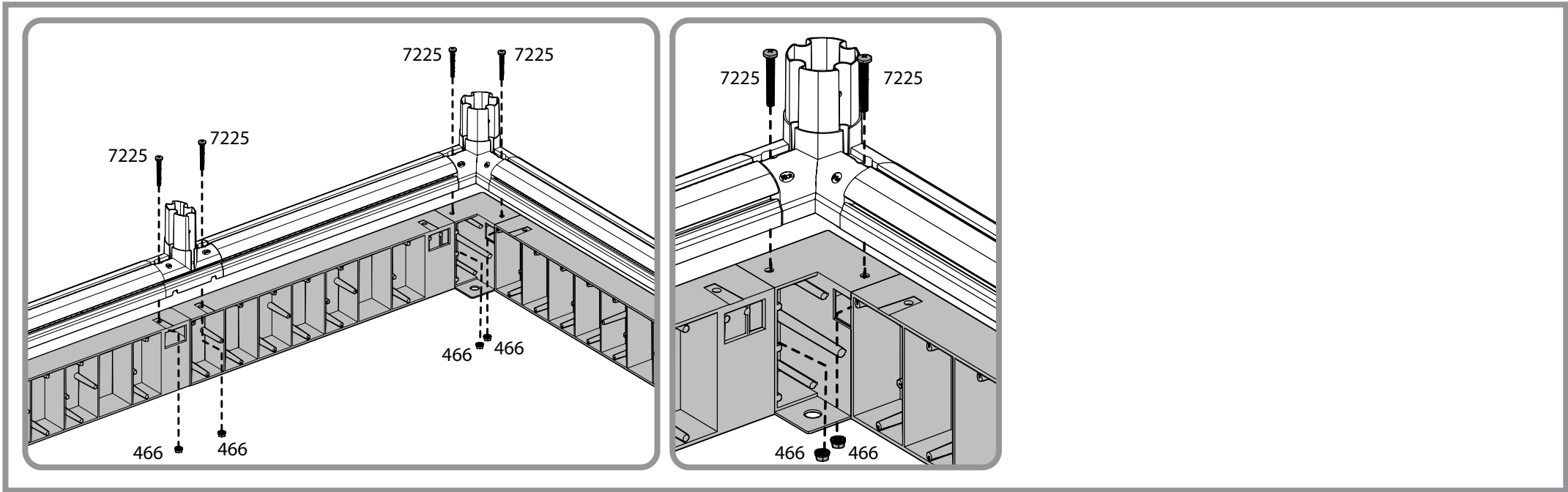

OPTION 1

When mounting above ground.

5



1. Attach the corners to the ground.
2. Secure the product to the foundation of your choice, using suitable screws & plugs or masonry anchors (not supplied). After securing the base kit, fill it with soil or concrete to the height of the kit.

Option 1

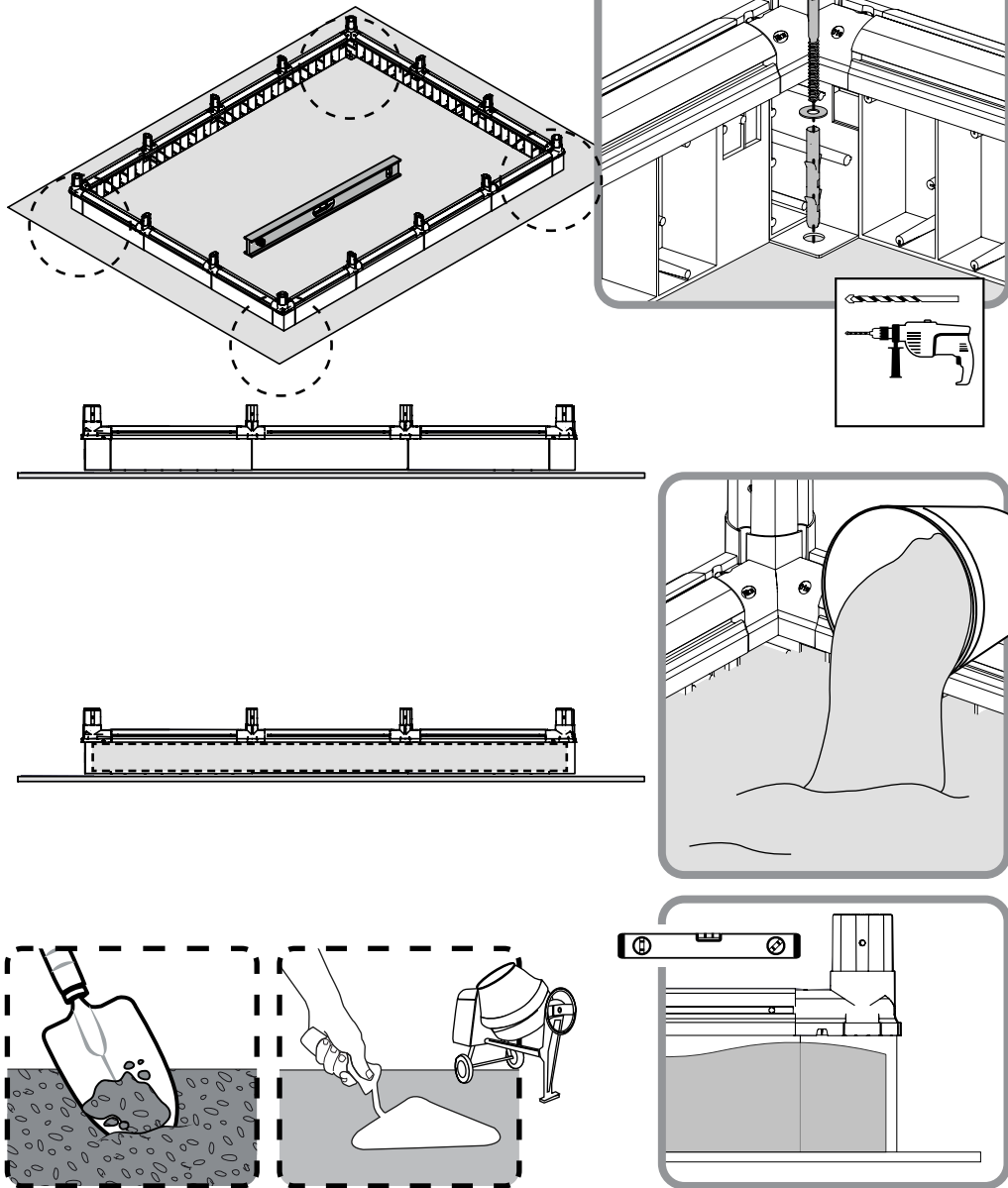

OPTION 2

When mounting on firm ground, grass, soil, or gravel.

1. Dig into the ground at the height of the kit, place the base kit inside and level it.
2. After securing the base kit, fill it with soil or concrete to the height of the kit.

Option 2

